



M.S.KENNEDY CORP.

20W
DC-DC
CONVERTERS

BBF2800S
SERIES

4707 Dey Road Liverpool, N.Y. 13088

(315) 701-6751

HI-REL DESIGN

- REPLACES APEX DB2800S SERIES
- SURFACE MOUNT MAGNETICS
- WELDED HERMETIC PACKAGE
- LOW INTERNAL TEMPERATURE GRADIENTS
- ALL CERAMIC CAPACITORS
- WITHSTANDS 5000G

OTHER FEATURES—SINGLE OUTPUT

- NO DERATING — -55°C to +125°C
- OUTPUT VOLTAGE ADJUSTMENT STANDARD
- REMOTE SHUTDOWN

DESCRIPTION

The BBF2800S series of DC-DC converters provides the ruggedness, reliability and features required to meet the advanced design challenges of today's hi-rel market. This has been accomplished using a package having very low thermal gradients, excellent hermeticity and high voltage isolation. The use of advanced substrate and reflow soldering techniques during construction results in a rugged, cost-effective pin solderable package.

The BBF2800S hybrid converter series utilizes all ceramic capacitors and surface mount magnetics to provide reliable operation at all operating temperatures while surviving very high G forces.

BBF2800S series standard features include kelvin sense, indefinite short circuit protection, remote shutdown, output fault monitoring, turn on voltage point adjustment, switching frequency synchronization of up to 3 units using no external components and pi-network input filtering. An output voltage adjustment/load compensation pin is also standard.

Fault tolerant design protects these converters from most external circuit faults. The output and output adjust pins will withstand +35V while the shutdown and all synchronization pins will withstand +50V protecting the converters from a variety of system or board faults, i.e. solder bridges, etc. Unique load fault protection circuitry allows this converter to pull up loads having difficult static load line characteristics and allows short term load excursions significantly beyond ratings in most applications.

The BBF2800 series is a current mode push-pull topology converter which operates at a switching frequency of 500KHz. Internal filtering of both input and output eliminates the need for external capacitors in many applications.

The 12-pin power dip package allows connection to a heatsink and is hermetically sealed and isolated from the internal circuits.

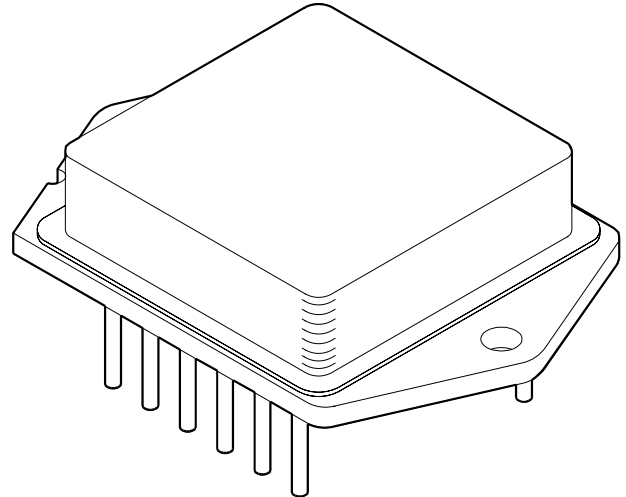

EXTERNAL CONNECTIONS

- | | |
|-----------------|-------------|
| 1 +INPUT | 12 -INPUT |
| 2 SHUTDOWN PLUS | 11 TIMING 2 |
| 3 CLOCK | 10 TIMING 1 |
| 4 ADJUST/COMP | 9 CASE |
| 5 -OUTPUT | 8 -SENSE |
| 6 +OUTPUT | 7 +SENSE |

BLOCK DIAGRAM

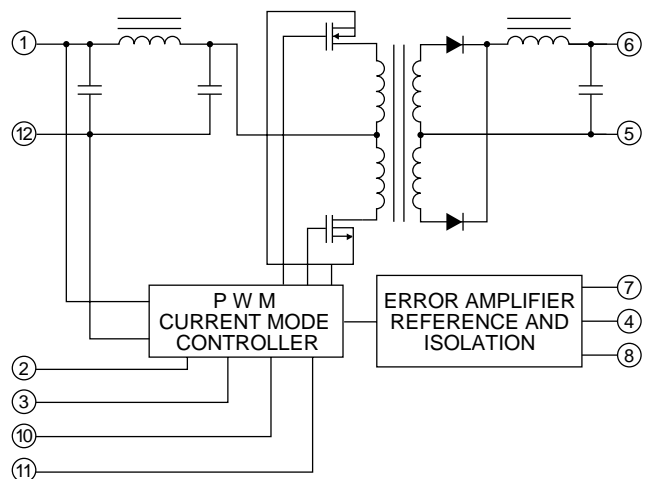

BBF2803S

ABSOLUTE MAXIMUM RATINGS SPECIFICATIONS

ABSOLUTE MAXIMUM RATINGS	INPUT VOLTAGE RANGE (Pin 12 to 1, 2, 3, 10 or 11)	0 - 50 Vdc
	INPUT TRANSIENT (Pin 12 to 1)	80 V @ 50 ms
	OUTPUT WITHSTAND (Pin 5 and 8 to 7, 6 or 4)	35 Vdc
	OUTPUT CURRENT (Continuous)	5.5 Adc BBF2803S 4.0 Adc BBF2805S 1.9 Adc BBF2812S 1.5 Adc BBF2815S
	TEMPERATURE, Storage	-65°C, 150°C
	TEMPERATURE, Pin Soldering 10s	300°C

SPECIFICATIONS

PARAMETER	TEST CONDITIONS ¹	BBF2803S			UNITS
		MIN	TYP	MAX	
STEADY STATE CHARACTERISTICS					
INPUT VOLTAGE RANGE		16	28	40	Vdc
OUTPUT VOLTAGE	V_{IN} : min to max Vdc @ I_{MIN}	3.2	3.3	3.4	Vdc
OUTPUT CURRENT	V_{IN} : min to max Vdc	500		5500	mAdc
EFFICIENCY			66		%
OUTPUT RIPPLE VOLTAGE	Bandwidth 10 kHz to 1MHz		20	50	mVrms
INPUT RIPPLE CURRENT	Bandwidth 10 kHz to 1MHz		20	50	mA rms
OUTPUT POWER ²		1.6		18.0	W
LINE REGULATION ³	V_{IN} : min to max ³		2	20	mVdc
LOAD REGULATION ³	I_{OUT} : min to max ³		1	15	mVdc
TEMPERATURE COEFFICIENT			.01		%/°C
TEMPERATURE RANGE, case ²		-55		125	°C
QUIESCENT CURRENT	$I_{OUT} = 0$ A		35	40	mAdc
INHIBITED	$V_{PINS} < 8$ Vdc	.09	1.25	2.5	mAdc
ISOLATION CHARACTERISTICS (INPUT/OUTPUT/CASE)					
LEAKAGE RESISTANCE	($V_{TEST} = 500$ Vdc)	100			MΩ
LEAKAGE CAPACITANCE	($f = 10$ kHz)		50		pF
DYNAMIC CHARACTERISTICS					
LINE STEP RESPONSE	V_{IN} ; T_R , $T_F = 10\mu s$				
VOLTAGE CHANGE	V_{IN} : 16 to 40 Vdc		300		mV
RECOVERY TIME (95%)			30		μs
WITH 100μF OUTPUT CAP					
VOLTAGE CHANGE	V_{IN} : 16 to 40 Vdc		100		mV
RECOVERY TIME (95%)			100		μs
LOAD STEP RESPONSE	I_{OUT} ; T_R , $T_F = 10\mu s$				
VOLTAGE CHANGE	I_{OUT} : 50% to max Adc		1400		mV
RECOVERY TIME (95%)			40		μs
WITH 100μF OUTPUT CAP					
VOLTAGE CHANGE	I_{OUT} : 50% to max Adc		300		mV
RECOVERY TIME (95%)			60		μs
START-UP OVERSHOOT	V_{IN} ; 0 to 40 Vdc		0		mV
SHUTDOWN DELAY	$V_{PINS} > 10$ Vdc to < 8 Vdc		220	500	μs
SHUTDOWN RECOVERY ⁴	$V_{PINS} < 8$ Vdc to > 10 Vdc		30	60	mS

- NOTES: 1. Unless otherwise stated: $T_C = 25^\circ$, $V_{IN} = 28$ V, $I_{OUT} = I_{MAX AMP}$
 2. Derate power linearly to zero from 125°C to 135°C.
 3. Regulation measured between pin 8 and pin 7.
 4. Recovery spec assumes that converter has been OFF for at least 500ms.

CAUTION

The internal substrate contains beryllia (BeO). Do not break the seal. If accidentally broken, do not crush, machine, or subject to temperatures in excess of 850°C to avoid generating toxic fumes.

BBF2805S			BBF2812S			BBF2815S			UNITS
MIN	TYP	MAX	MIN	TYP	MAX	MIN	TYP	MAX	
16	28	40	16	28	40	16	28	40	Vdc
5.00	5.05	5.1	12.00	12.05	12.1	15.0	15.1	15.2	Vdc
400		4000	190		1900	150		1500	mAdc
	70			72			73		%
	20	50		25	50		25	50	mVrms
	20	30		20	30		20	30	mArms
2		20	2.3		23	2.2		22	W
	5	50		5	50		10	50	mVdc
	2	25		5	50		20	50	mVdc
	.01			.01			.01		%/°C
-55		125	-55		125	-55		125	°C
	35	40		35	40		35	40	mAdc
.09	1.25	2.5	.09	1.25	2.5	.9	1.25	2.5	mAdc
100			100			100			MΩ
	50			80			85		pF
	400			300			300		mV
	30			40			40		μs
	200			150			150		mV
	250			250			250		μs
	1400			800			800		mV
	40			60			60		μs
	500			280			280		mV
	150			400			400		μs
	0			0			0		mV
	220	500		220	500		220	500	μs
	30	60		30	60		30	60	ms

PACKAGE THERMAL SPECIFICATIONS

	MIN	TYP	MAX	UNITS
RESISTANCE, case to air		12		°C/W
TEMPERATURE RISE, junction to case		10	15	°C

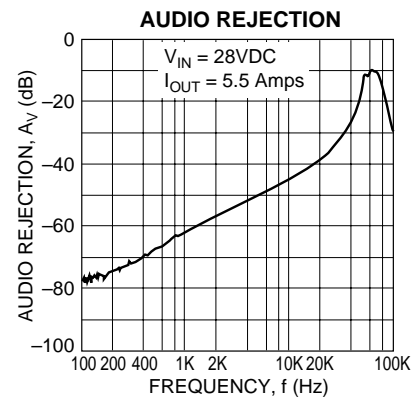
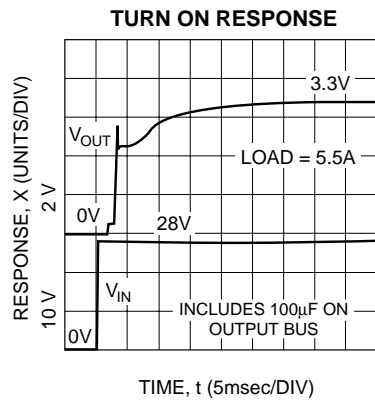
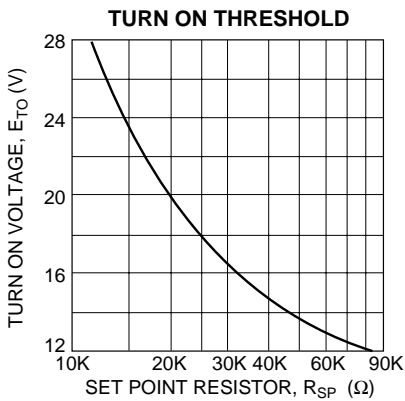
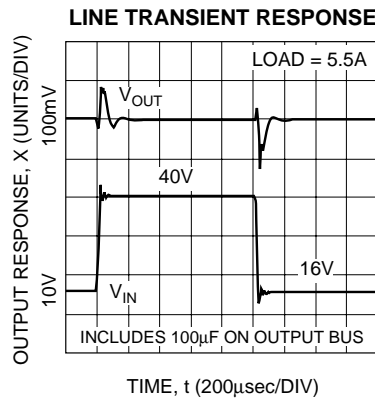
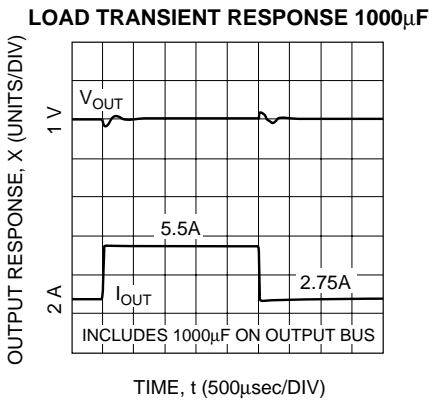
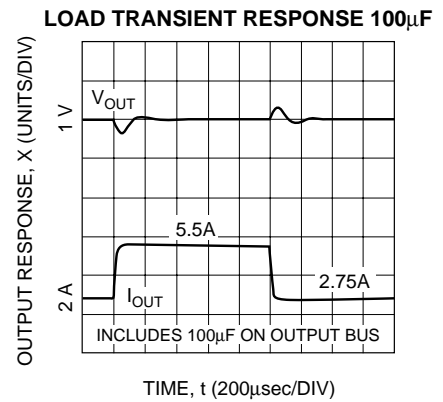
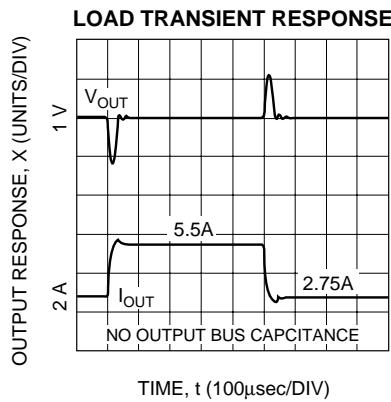
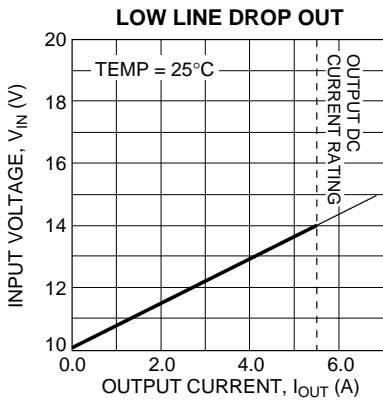
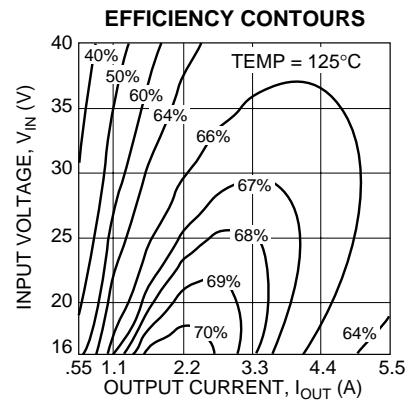
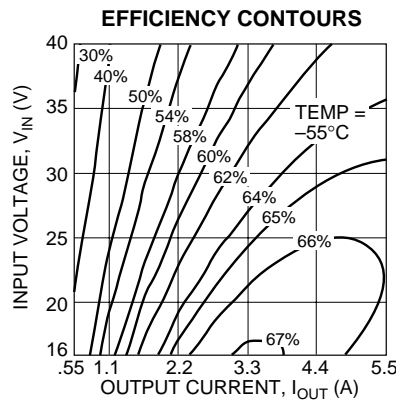
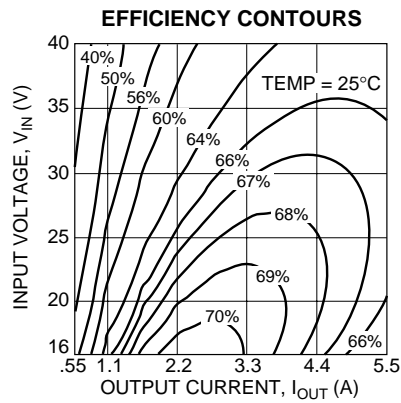

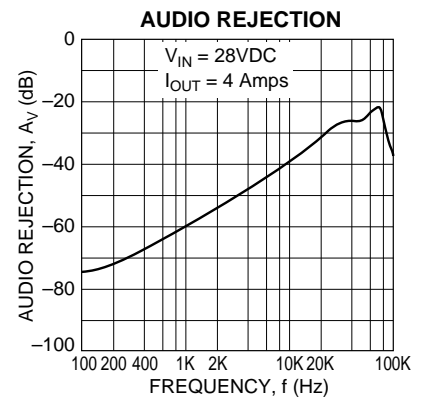
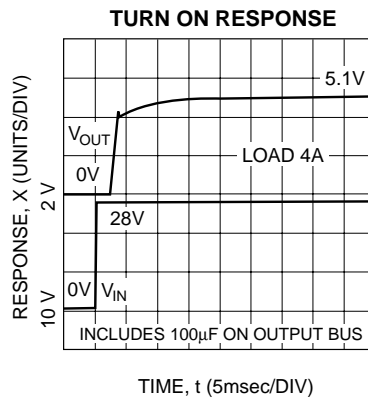
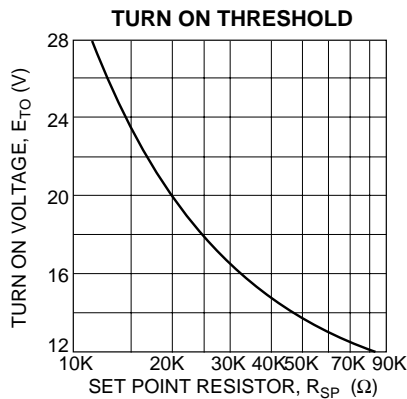
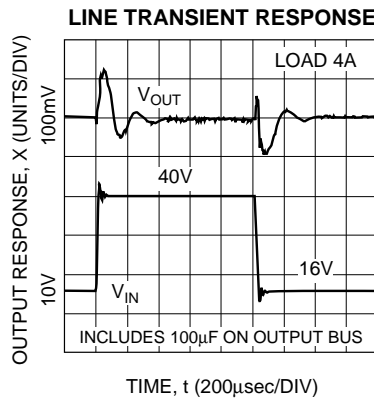
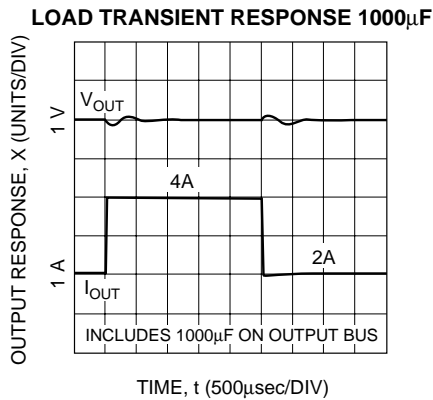
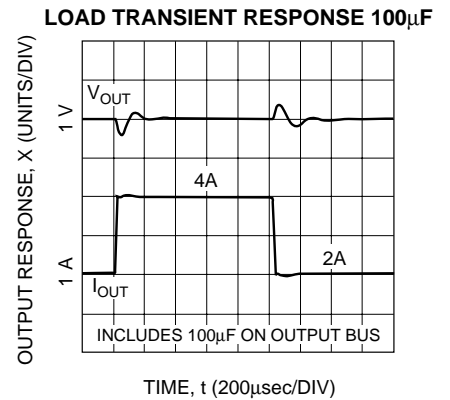
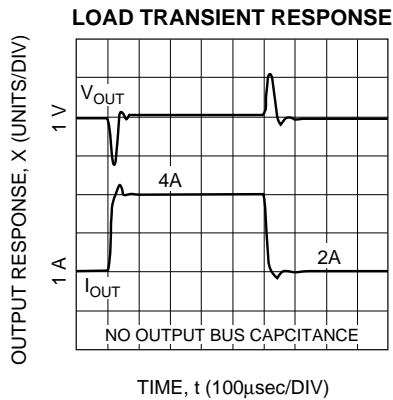
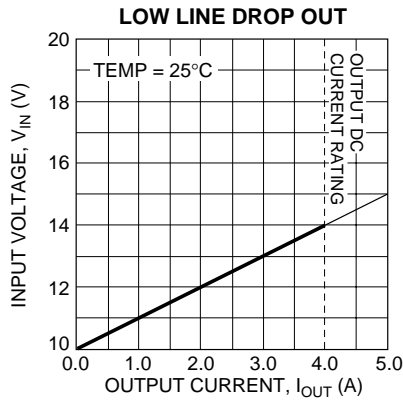
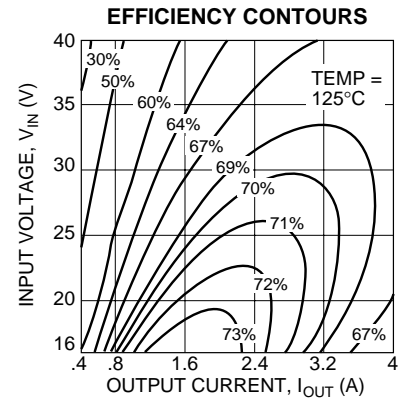
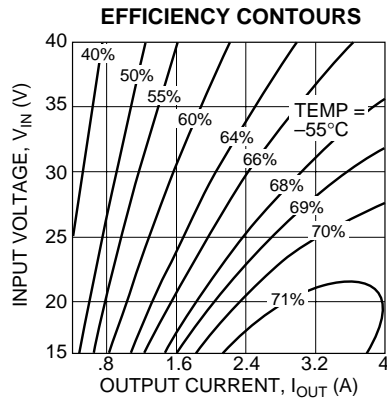
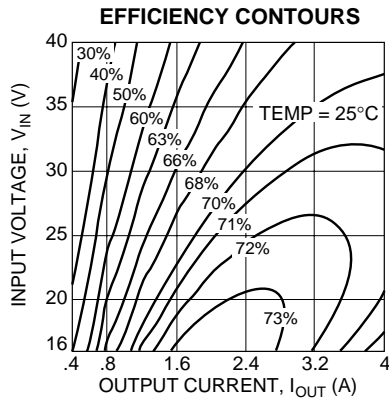

OUTPUT ADJUST / COMP

The output voltage of the BBF2800S may be adjusted from 90% to 110% of nominal value by the use of a 50KΩ potentiometer as shown. Adjustment beyond this range is possible however certain characteristics of the converter such as but not limited to input voltage range, efficiency, ripple and temperature performance will change. Characterization by the user is recommended in such applications.

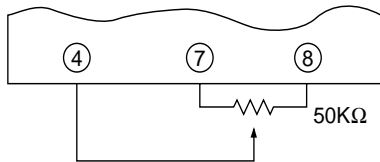

Adjust/comp (pin 4) may be driven by external circuitry referenced to pin 8 (-output sense) if desired. Grounding pin 4 causes output voltage to increase (25% typically) while driving pin 4 above 1.3 V causes output voltage to decrease. Pin 4 may be driven through 10KΩ or more if connection of the comp function is also required.

The comp function of pin 4 allows transient response and phase margin to be tailored to suit a specific application. This feature may be utilized by connecting a small (1-500 nf) capacitor between pins 4 and 6 or 7. This is generally recommended when very large low ESR load capacitances are used.

SHUTDOWN PLUS

Pin 2 is used for remote shutdown, output fault detection, and/or setting the input voltage point at which the converter will turn on as shown in the typical application diagram. No connection to pin 2 is necessary for normal operation of the converter. Pin 2 is referenced to pin 12 (-input).

Shutdown may be implemented by simply connecting pin 2 to an open collector logic output or switch rated at 2.5 mA, 25 Vdc or higher.

Input voltage turn on point is programmed with a single resistor from pin 2 to 12. An input turn on/off hysteresis (typically 3.5% of V_{in}) will be observed. This should be considered when making or verifying set point adjustment. The value of the setpoint resistor may be determined by the following:

$$R = \frac{210 \cdot 10^3}{E_{TO} - 9.5} \quad (\pm 10\% \text{ accuracy at } 25^\circ\text{C})$$

Set point temperature coefficient is typically +400ppm/°C. Output fault monitoring is accomplished by observing pin 2 with a high impedance monitoring circuit. Pin 2 voltage drops from over 10 V to below 1 V when a load fault causes the converters fault protection circuitry to activate. It will remain low for at least 100 mS and return high. If the load fault is still present pin 2 will return low and the cycle will repeat. If there is no input setpoint programming resistor already in place a resistor > 400 KΩ from pin 2 to 12 will provide pin 2 pull down.

MULTIPLE CONVERTER SYNCHRONIZATION

Synchronized operation of up to three BBF2800S series converters may be accomplished without external components. One unit selected to be the master is connected normally with pin 10 grounded. The clock output pin 3 will provide the sync signal for up to two slave units. The slave units have pin 10 not connected and receive the clock signal into pin 11. The clock signal lines may be shielded to prevent radiation. A separate 50 ohm coax to each slave unit is recommended in order to preserve signal integrity. Shield ends should be connected to pin 12 of the nearest converter.

BBF2800S converters may also be synchronized to an external 500 KHz (+/- 5%) frequency source driving pin 11 of the converters. Pin 10 is not connected. The converters synchronize to the positive edge of the frequency source allowing a variety of wave forms (pulse, square, spike) to be used. Pin 11 is internally capacitively coupled allowing unipolar or bipolar frequency sources to be used. The source should have a waveform rise time of 20 ns or less and be capable of driving at least 4 volts peak into each 50 ohm pin 11 input (50 volts peak max).

An externally synchronized unit may be used to synchronize other (slave) units. The slave units may be used in turn to synchronize other slave units from their pin 3 outputs. Each "generation" of slave units has a delay (100-200ns typical) from the unit that it is synchronizing to.

TYPICAL APPLICATION

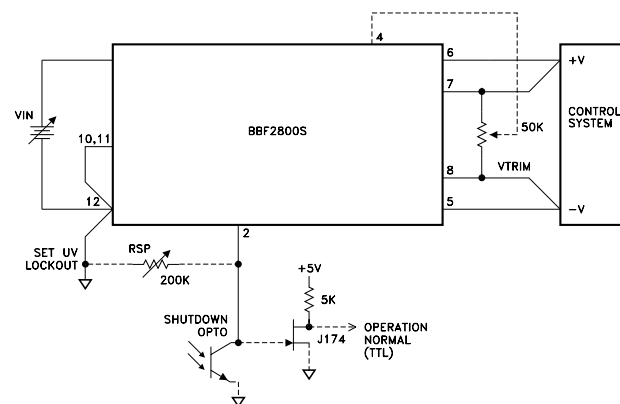

The above diagram shows the remote sense feature which reduces V_o errors due to the resistance of the conductors feeding the load. This diagram also shows the connections for non-synchronized operation (TIMING 1 and 2) as well as output voltage trim, remote shutdown, fault monitoring, and input voltage turn on point adjustment.

MECHANICAL SPECIFICATIONS

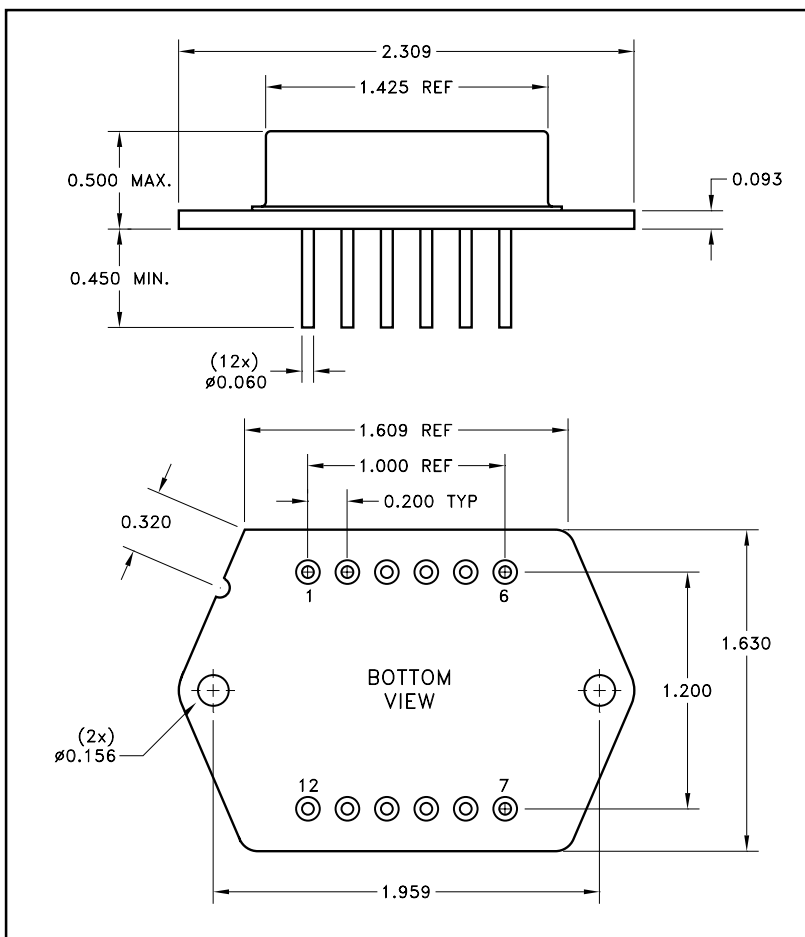

NOTE: ALL DIMENSIONS ARE ±0.010 INCHES UNLESS OTHERWISE LABELED.
ESD Triangle indicates Pin 1.

ORDERING INFORMATION

BBF2812S

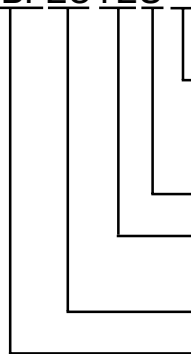

SCREENING

BLANK = INDUSTRIAL; E = EXTENDED RELIABILITY;
H = CLASS H; K = CLASS K

SINGLE OUTPUT

OUTPUT VOLTAGE

03 = 3.3V; 05 = 5V; 12 = 12V; 15 = 15V

NOMINAL INPUT VOLTAGE

GENERAL PART NUMBER

The above example is an industrial grade 12V single output converter

M.S. Kennedy Corp.

4707 Dey Road, Liverpool, New York 13088

Phone (315) 701-6751

FAX (315) 701-6752

www.mskennedy.com

The information contained herein is believed to be accurate at the time of printing. MSK reserves the right to make changes to its products or specifications without notice, however, and assumes no liability for the use of its products. Please visit our website for the most recent revision of this datasheet.